



CR3240



3.38" x 20.63" x 19.13" (H x W x D)

230V three-burner cooktop in black ceramic glass, made in Europe

Highlights:

Three-burner electric cooktop with 230V operation

Smooth black ceramic glass surface offers easy cleanup and modern style

Includes push-to-turn knobs and heat indicator light for safer use

Product Features:

Smooth black surface made from Eurokera glass Easy cleanup and elegant style on a smooth ceramic glass surface

Three heating elements 3 1200W burners, each with 6" diameter, manufactured for SUMMIT by E.G.O. of Germany, considered by many to be the finest in the world

Push-to-turn controls Prevents accidents by requiring a small amount of force to turn on cooktop heat

Residual heat indicator light Indicates when surface is still hot to touch

Designed for built-in installation Fits counter cutout sizes that are 19 7/8" wide by 18 3/8" deep

ADA compliant design Upfront controls and easy-to-operate knobs offer easier accessibility



CR3240 Specifications:

Overview	
Height of Cabinet	3.38" (9 cm)
Width	20.63" (52 cm)
Depth	19.13" (49 cm)
Cabinet	Black
US Electrical Safety	UL
Canadian Electrical Safety	ULC
Voltage/Frequency	230 V AC/60 Hz
Weight	15.0 lbs. (7 kg)
Shipping Weight	24.5 lbs. (11 kg)
Parts & Labor Warranty	1 Year
UPC	761101023649
Electric Cooktop	
Heating Type	Radiant
Surface	Glass
Element Type	Glasstop
Number of Elements	3
Controls	Dial
Countertop Cutout Height	3.38" (9 cm)
Countertop Cutout Width	19.88" (50 cm)
Countertop Cutout Depth	18.38" (47 cm)
Power Source	230V
Element #1 Size	6.0" (15 cm)
Element #1 Wattage	1200.0
Element #2 Size	6.0" (15 cm)
Element #2 Wattage	1200.0
Element #3 Size	6.0" (15 cm)
Element #3 Wattage	1200.0
Power Cord Included	No

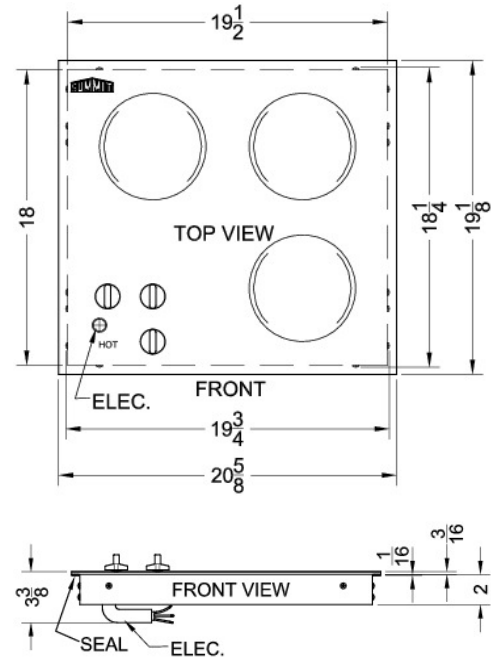

MODEL: CR3240
240V-60Hz 3600W